

PRODUCT No. 5057-2

Tube container KLASIK with reinforced construction – 7 m³



(Illustrative photograph)

Technical data

Material	Steel sheet
Mat. thickness (bottom/walls)	5/3 mm
Capacity	7 m ³
Weight	650 kg
Width	1820 mm
Length	3500 mm
Height	1400 mm

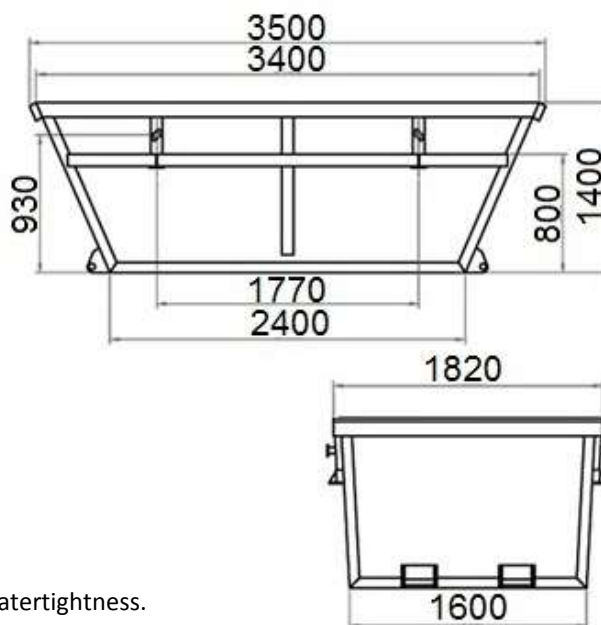

Attributes

- Made of steel sheet.
- Containers are welded from the inside and outside – ensuring watertightness.
- Surface finish – base + top layer of paint.
- Safety clamps on the bottom are manufactured in two options – West-European type and Czech type.
- Czech type – two lifting attachments side by side.
- West-European type – one lifting attachment.
- Primarily suitable for storage and transport of paste state wastes.

Color variations

- According to RAL sampler.

Product purpose

- Designed primarily for storage and transport of paste state wastes.

Additions

- When transporting the container, it must be secured against movement by safety clamps on the bottom.