

PRODUCT No. 7261

Mobile system rack – 1020 x 500 x 1686



(Illustrative photograph)

Technical data

Material	Steel sheet
Weight	59,3 kg
Load capacity	30 kg
Width	1020 mm
Depth	500 mm
Height	1686 mm

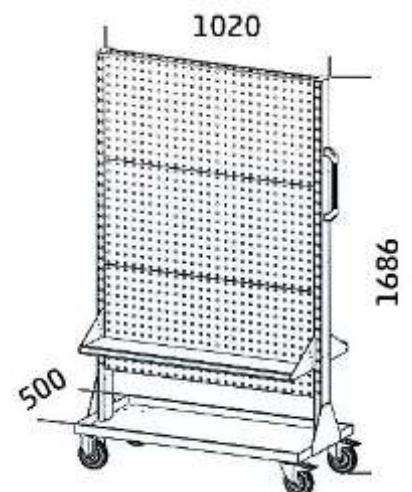

Attributes

- Made of steel sheet.
- Intended for intensive everyday use in an industrial plants, warehouses, tool supply points and shops.
- Chassis fitted with – 2x fixed and 2x turnable wheels of 100 mm diameter.
- Equipped with side handle for easy manipulation.

Product purpose

- Designed for storing of tools or clips for material.

Additions

- The construction is equipped with perforated panels for installation of holders for tools, plastic clips or shelves.