

PRODUCT No. 4727

Container with tiltable bottom – 1000 l



(Illustration photograph)

Technical data

Material	Steel sheet
Material thickness (walls / bottom)	3 mm
Weight	135 kg
Capacity	1000 l
Load capacity	800 kg
Length (outer/inner)	1500/1350 mm
Width (outer/inner)	1080/1000 mm
Height (outer/inner)	970/750 mm

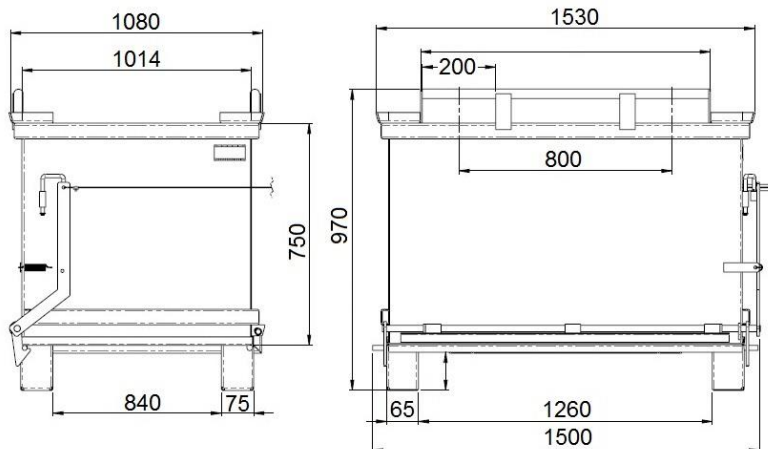

Attributes

- Made of steel sheet.
- Special container with tiltable bottom.
- Robust design which secures sufficient strength.
- Disconnecting the bottom by means of a cable can be carried out from the VZV driver's seat.
- Re-closing the bottom can be made by cautious placing the container on ground (the bottom is automatically secured).
- Manipulation with container – by fork-lift or crane is possible because of four meshes.
- Surface finishing is made by base layer and top layer varnishing.

Product purpose

- Designed for collection of usual waste.