

PRODUCT No. 6007

Turnable wheel – 80 mm



(Illustration photograph)

Technical data

Material	Galvanized-steel/Rubber
Type	Turnable
Bearing	Needle bearing
Weight	0,9 kg
Load capacity (Dynamic/static)	70 / 140 kg
Temperature resistance	-20/+60°C
Thread width	30 mm
Wheel diameter	100 mm
Plate holes centres	80/77 x 60 mm
Plate size	105 x 85 mm
Height (total)	128 mm
Plate hole diameter	9 mm

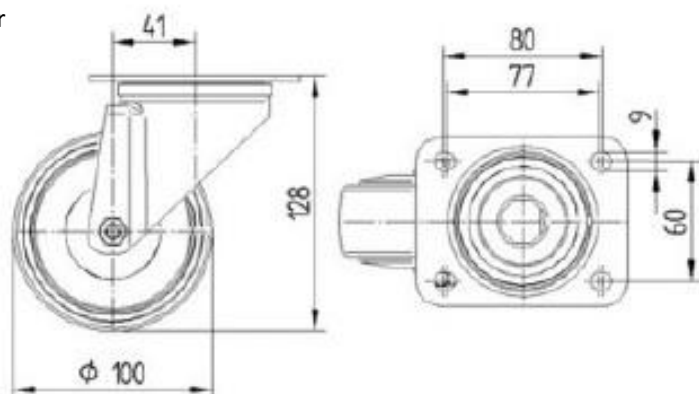

Attributes

- Made of pressed galvanized steel – forks. Wheel is made of rubber.
- Reinforced steel fork in galvanized surface finishing.
- Can be used in manufacturing industry – transport trolleys or in a construction industry for scaffolding, etc.
- In accordance with EN 12532 regulation – Pulleys and wheels for speeds up to 4 km/h.

Product purpose

- Designed as transportation wheel.

Additions

- Offered as – fixed, turnable and turnable with brake types.
- Offered in different sizes - with 80 mm to 200 mm wheel diameter.