

PRODUCT No. 6344

Fixed transport wheel with plastic center – 200 mm



(Illustration photograph)

Technical data

Material	Galvanized-steel/PP/Rubber
Type	Fixed
Bearing	Needle bearing
Weight	2,3 kg
Load capacity (Dynamic/static)	205 / 410 kg
Temperature resistance	-20/+60°C
Thread width	50 mm
Wheel diameter	200 mm
Plate holes centres	80/75 x 105 mm
Plate size	137 x 115 mm
Height (total)	240 mm
Plate hole diameter	11 mm

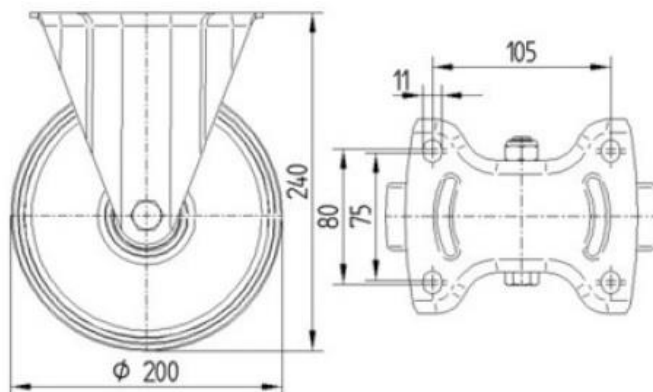

Attributes

- Made of pressed galvanized steel – forks. Wheel is made of rubber with polypropylene center part.
- Reinforced steel fork in galvanized surface finishing.
- Can be used with wide range of manipulation means.
- In accordance with EN 12532 regulation – Pulleys and wheels for speeds up to 4 km/h.

Product purpose

- Designed as transportation wheel.

Additions

- Offered as – fixed, turnable and turnable with brake types.
- Offered in different sizes - with 80 mm to 200 mm wheel diameter.