

PRODUCT No. 3559-7
Double hook 90°, 50 mm

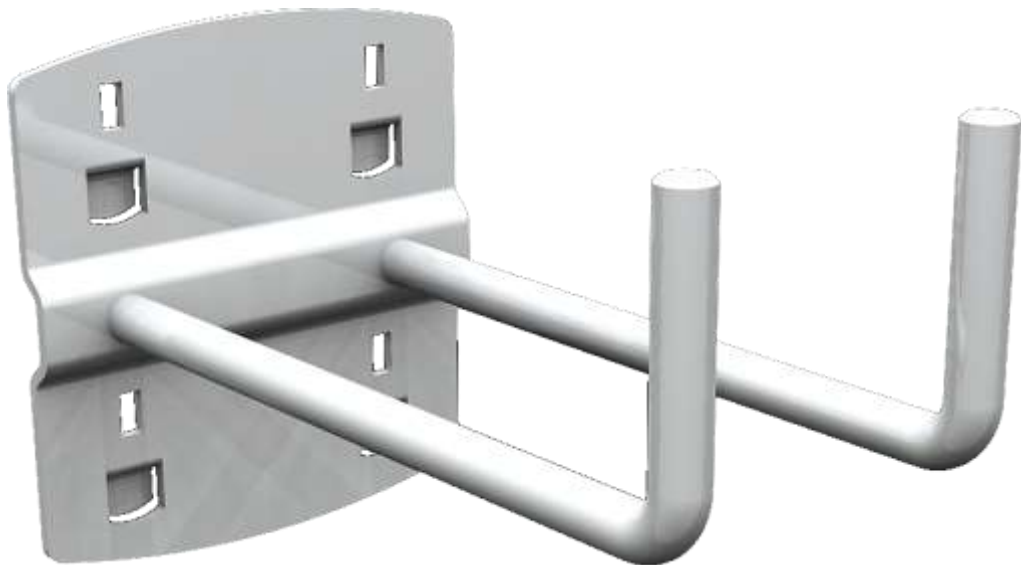

(Illustrative photograph)

Technical data

Material	Steel
Weight	0,6 kg
Package	5 pcs
Angle	90°
Length (L)	50 mm

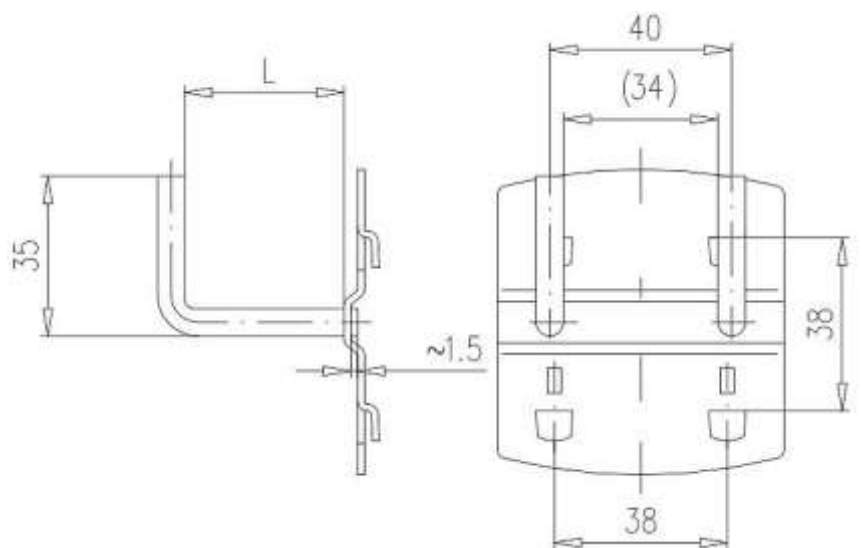

Attributes

- Made of steel.
- Possible to use for easy and safe storage of tools, plastic trays and other parts.
- Holders are hanged on a Q-system panels, perforated wall cabinets, tables or service trolleys.
- Surface finishing is made by galvanization.

Product purpose

- Designed for hanging into perforations for easy and safe storage of tools.