

PRODUCT No. 7144

Chamfered storage box – 300 x 400 x 200 mm



(Illustrative photograph)

Technical data

Material	Steel sheet
Capacity	20 l
Weight	2,3 kg
Load capacity	40 kg
Width	300 mm
Depth	400 mm
Height	200 mm

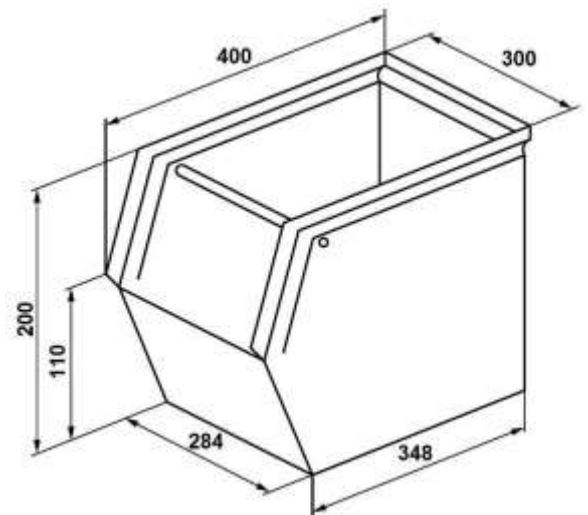

Attributes

- Made of steel sheet.
- Chamfered boxes have handle bar instead of front grip.
- Suitable for storage areas, during assembly operations and internal-operation manipulation.
- Obtained with stacking system which enables storing in multi-layer storage.
- Surface finishing is made by powder paint coating.

Color variations

- Grey (RAL 7037).

Product purpose

- Designed for storing and transportation of common material.

Additions

- With a large purchase, a surface finishing by galvanization can be done.
- Can be delivered without surface finishing.