

PRODUCT No. 7150

Flat storage box – 200 x 400 x 200 mm



(Illustrative photograph)

### Technical data

Material	Steel sheet
Capacity	13 l
Weight	2,3 kg
Load capacity	40 kg
Width	200 mm
Depth	400 mm
Height	200 mm

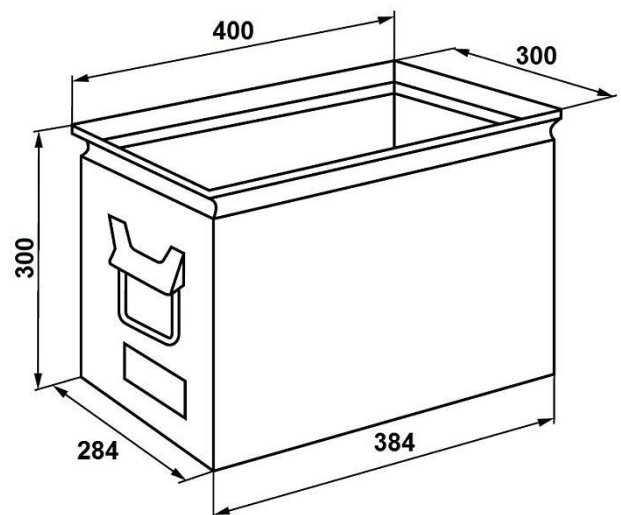

### Attributes

- Made of steel sheet.
- Chamfered boxes have handle bar instead of front grip.
- Suitable for storage areas, during assembly operations and internal-operation manipulation.
- Obtained with stacking system which enables storing in multi-layer storage.
- Surface finishing is made by powder paint coating.

### Color variations

- Grey (RAL 7037).

### Product purpose

- Designed for storing and transportation of common material.

### Additions

- With a large purchase, a surface finishing by galvanization can be done.
- Can be delivered without surface finishing.