

PRODUCT No. 3769-1

Polyethylene container with bottom dump – 2,5 m³ – Paper



(Illustration photograph)

Technical data

Material	Polyethylene (PE)
Capacity	2,5 m ³
Weight (approx.)	120 kg
Load capacity (approx.)	624 kg
Noise level	87 dB
Width	1825 mm
Depth	1230 mm
Height	1665 mm

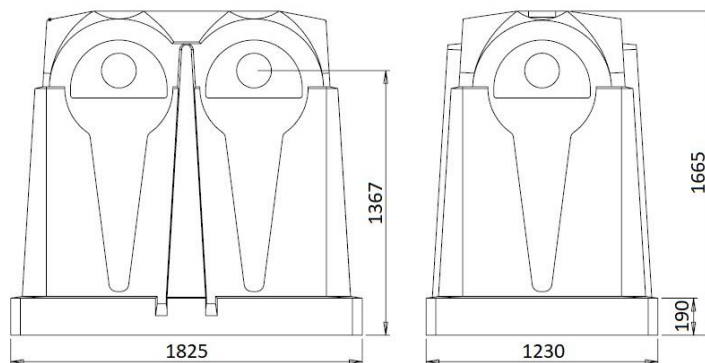

Attributes

- Made of high-quality Polyethylene by rotary moulding method.
- Equipped with a mechanism of emptying - with the arm loader.
- Equipped with bottom dump mechanism, double-part bottom - double hook system.
- Resistant to mechanical damage, weather influences and because of it's base it is resistant against turning over.
- Containers are color-stable, UV stable.
- Containers are designed for collection of separated waste.
- Containers are color-coded by the type of waste.
- Minimal surface porosity ensures easy cleaning of the container
- Openings are adjusted for the type of collected waste.

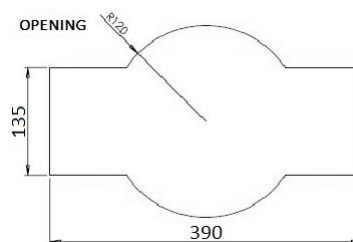

Color variations

- Blue version – collection of paper.

Product purpose

- Designed for separated waste collection – the blue version is designed for paper collection.