

Plastic container – 180 l
TYPE: 0008

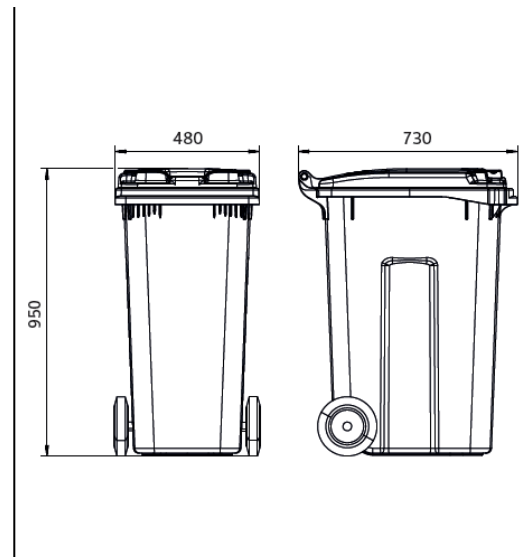

Illustrational photograph

TECHNICAL DATA

Material	Plastic (HDPE)
Capacity	180 l
Weight	9 kg (± 5 %)
Max. weight	90 kg (± 5 %)
Load capacity	72 kg (± 5 %)
Wheel diameter	200 mm
Dimensions (W x D x H)	480 x 730 x 950 mm

ATTRIBUTES

- Made of 100 % recyclable plastic high-density polyethylene (HDPE).
- Standardly delivered with two rubber wheels with plastic centres with 200 mm diameter.
- Wheels are supplied with metal axle.
- Manufactured in accordance of EN 840 regulation and certified according to RAL-GZ 951/1.
- Resistant to UV radiation, chemical and biological impacts or to frost.
- Smooth surfaces help against sticking of waste on them.
- Production materials does not contain any cadmium and can be granulated again.

COLOUR VARIATIONS

0008-2 (Green RAL-6002), 0008-3 (Black RAL-7016).

PRODUCT PURPOSE

Product is designed as collection container for municipal waste separation.

ADDITIONS

Not suitable for storing of hot ash.
Production material is recyclable.
Material does not contain cadmium.
Thermoprinted logo.

