

PRODUCT No. 4903

Wardrobe on the base – grey/blue



(Illustrative photograph)

Technical data

Material	Steel sheet
Weight/capacity (approx.)	37,8 kg / 2x 245 l
Lock	Cylindric
Color variation	Grey/blue (RAL 7035/5012)
Base	40 mm
Section No.	2x
Doors in section No.	1x
Section width	300 mm
Width	600 mm
Depth	500 mm
Height	1800 mm

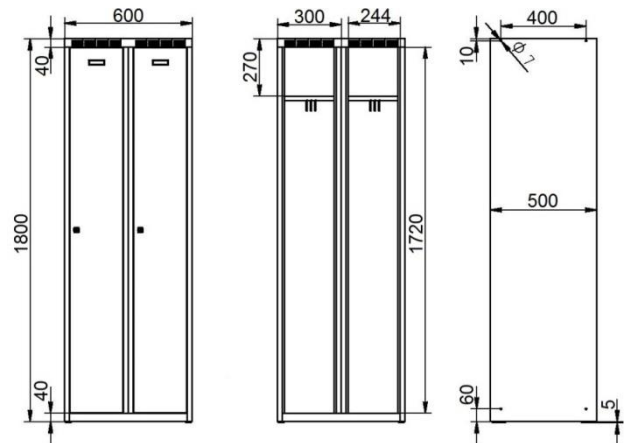

Attributes

- Made of steel sheet of thickness from 0,6 mm (housing) to 1 mm (bottom and upper part).
- High quality welded design.
- Effective ventilation system.
- Highly resistant to violent intrusion – double layered housing, door stopper.
- Each section is individually lockable by a cylindrical lock.
- High quality surface finishing – RAL 7035 for body and RAL 5012 for doors.
- Equipped with openings on sides for connecting wardrobes into line.
- Equipped with: Shelf, bar for hangers, 3x hook.

Color variations

- Body/doors – grey (RAL 7035)/blue (RAL 5012)

Product purpose

- Designed for storing of personal/work items and clothing.

Additions

- Also available in grey doors version (RAL 7035).
- Safety turnable padlock for hanging lock can be ordered.
- New design ensures high burglary resistance.